

CUTSHEET

Front View

Side View

Top View

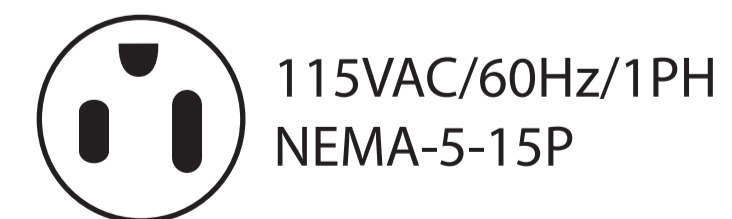
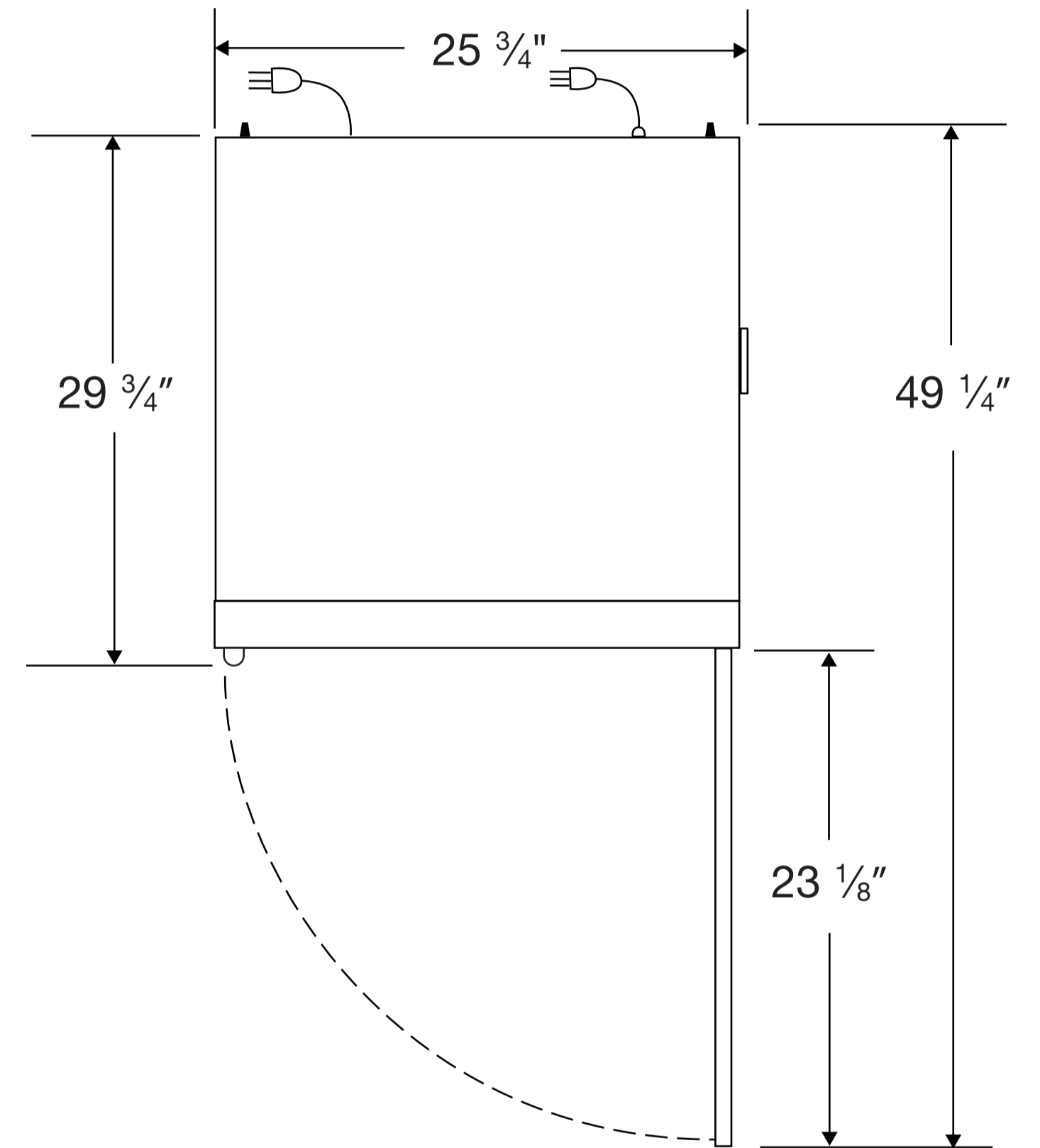
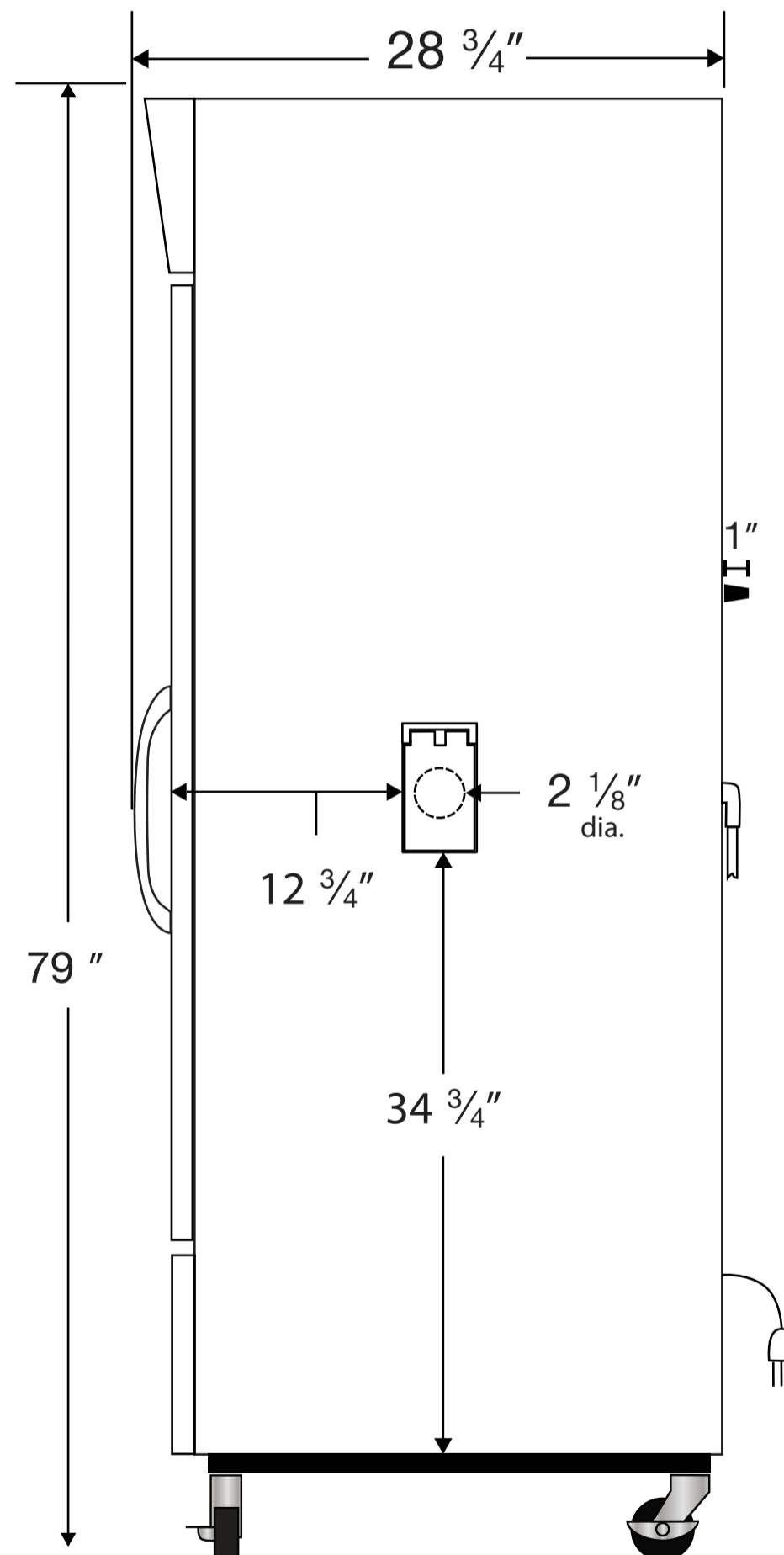
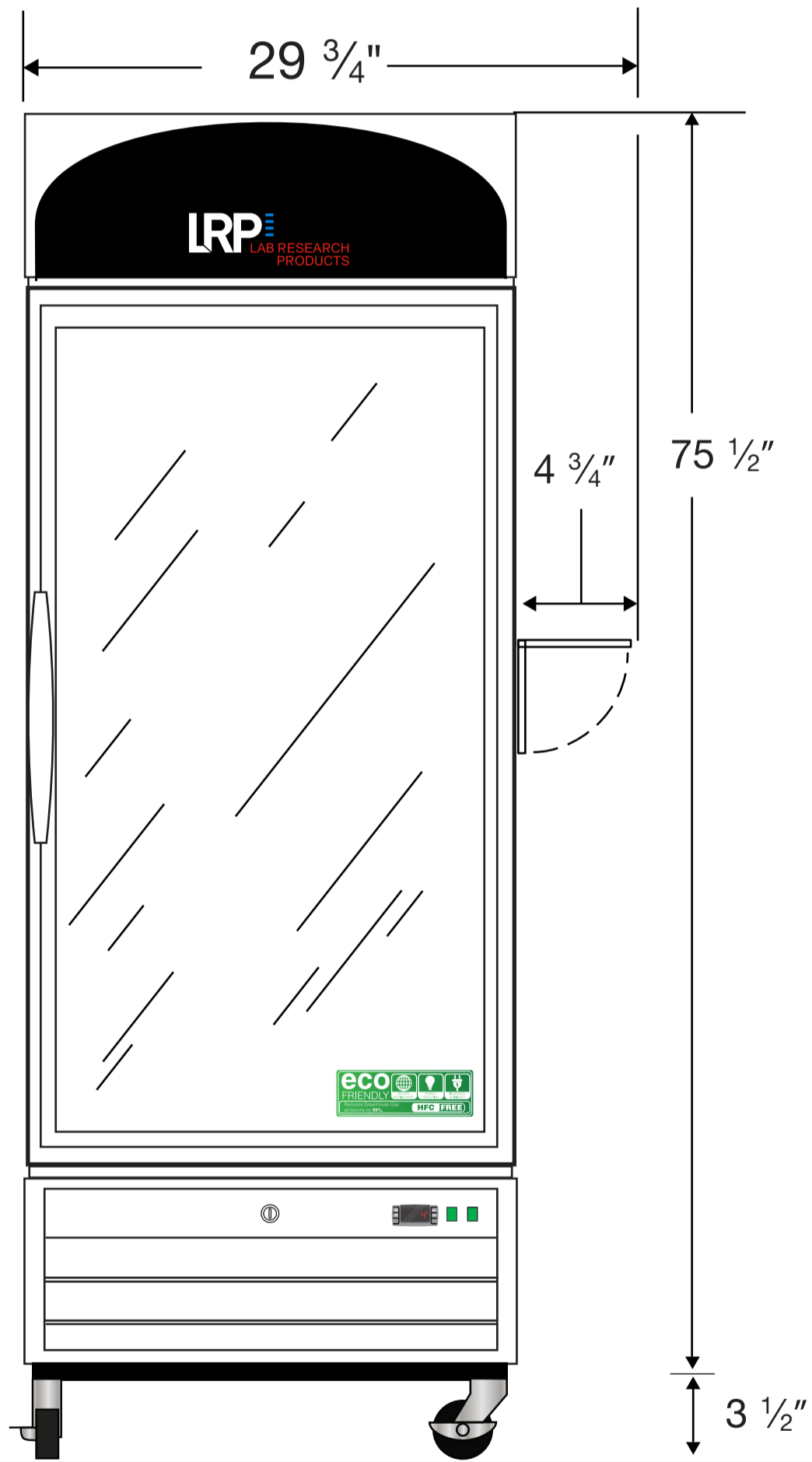

Cu. Ft	Defrost	Door	Int Door	Shelves	W"	D"	H"	Refrigerant	H.P.	Amps	Weight
16	Cycle	1 Glass	0	3 Adj	25 3/4	29 3/4	79	R290	1/5	3	243 lbs.