

CUTSHEET

Front View

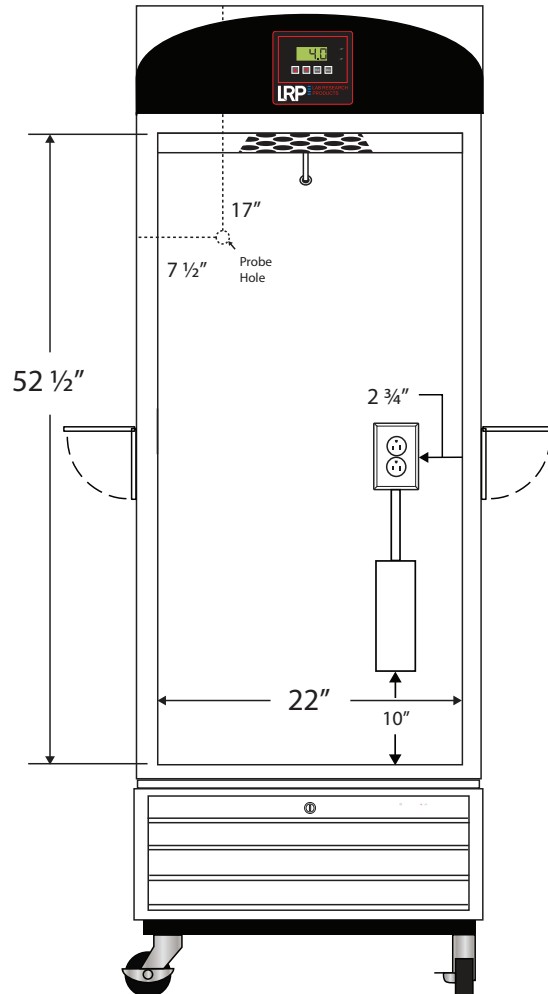

Side View

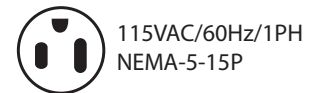
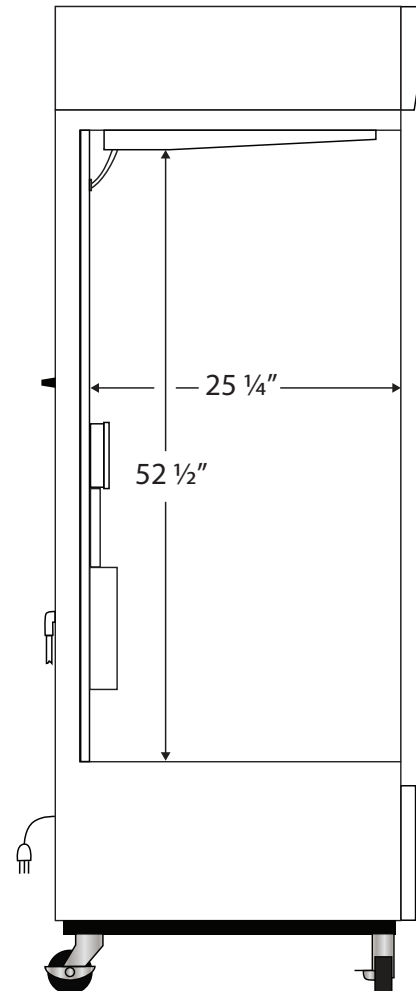

Cu. Ft	Defrost	Door	Int Door	Shelves	Interior Dim.			Refrigerant	H.P.	Amps	Weight
					W"	D"	H"				
23	Cycle	1 Glass	0	4 Adj	22	25 1/4	52 1/2	R290	1/5	3	296 lbs.

Note: Interior dimensions are estimates and subject to change without notice