

Front View

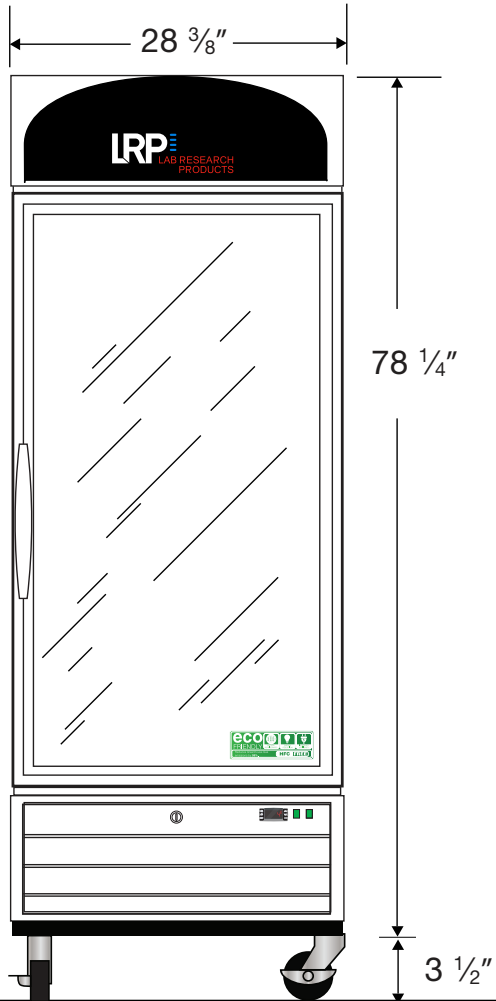

Side View

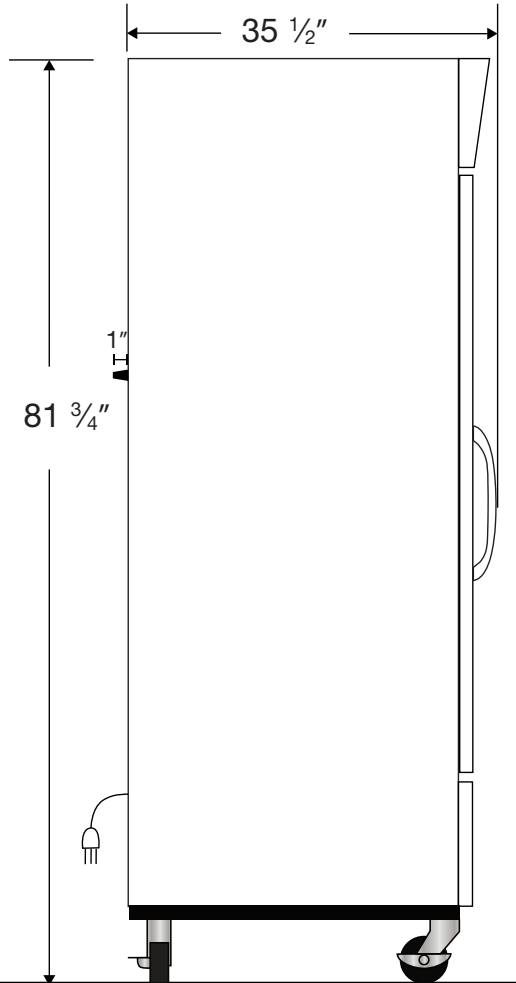

Top View

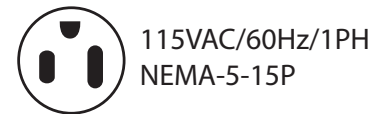
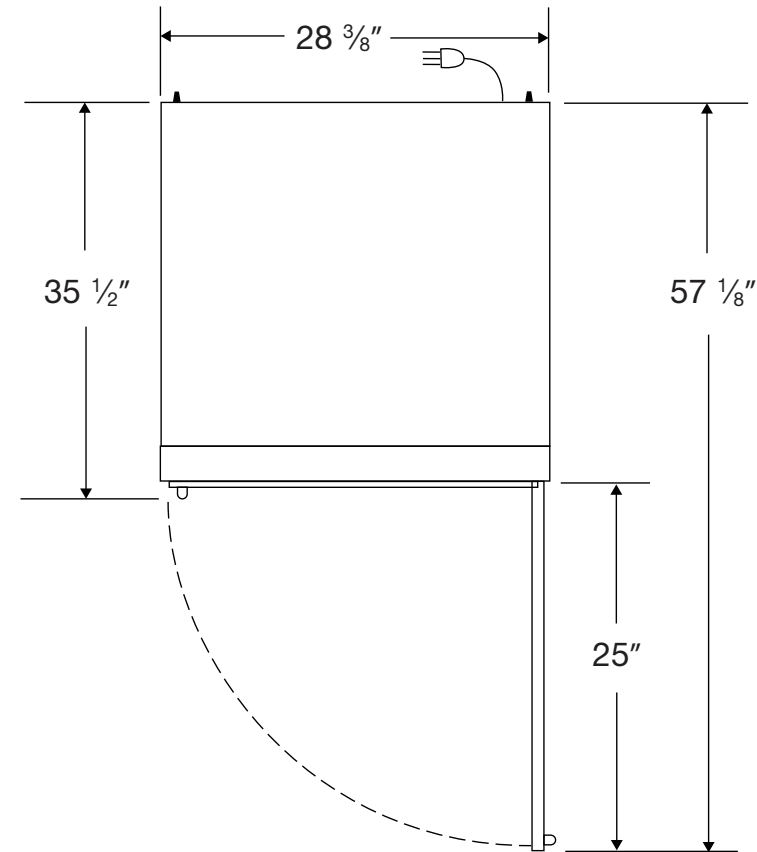

Cu. Ft	Defrost	Door	Int Door	Shelves	W"	D"	H"	Refrigerant	H.P.	Amps	Weight
26	Cycle	1 Glass	0	4 Adj	28 <sup>3</sup> / <sub>8</sub>	36 <sup>1</sup> / <sub>2</sub>	81 <sup>3</sup> / <sub>4</sub>	R290	<sup>1</sup> / <sub>5</sub>	3	315 lbs.