

Front View

Side View

Top View

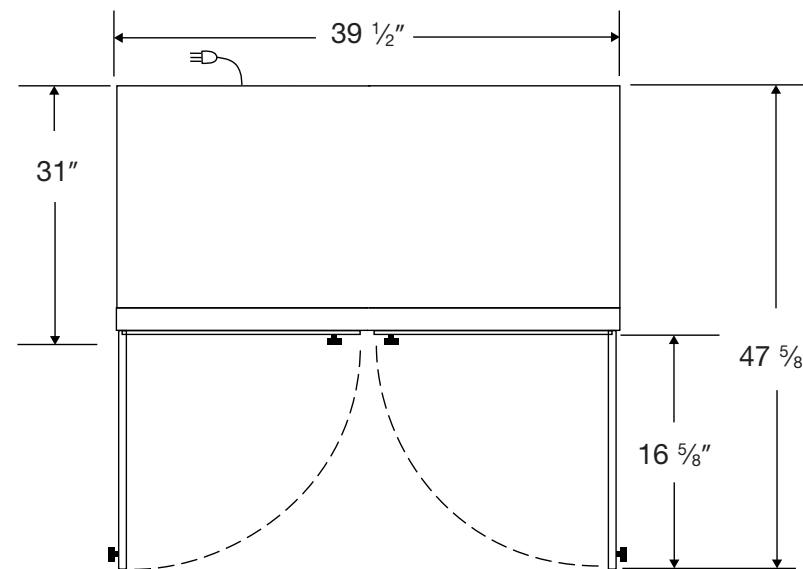
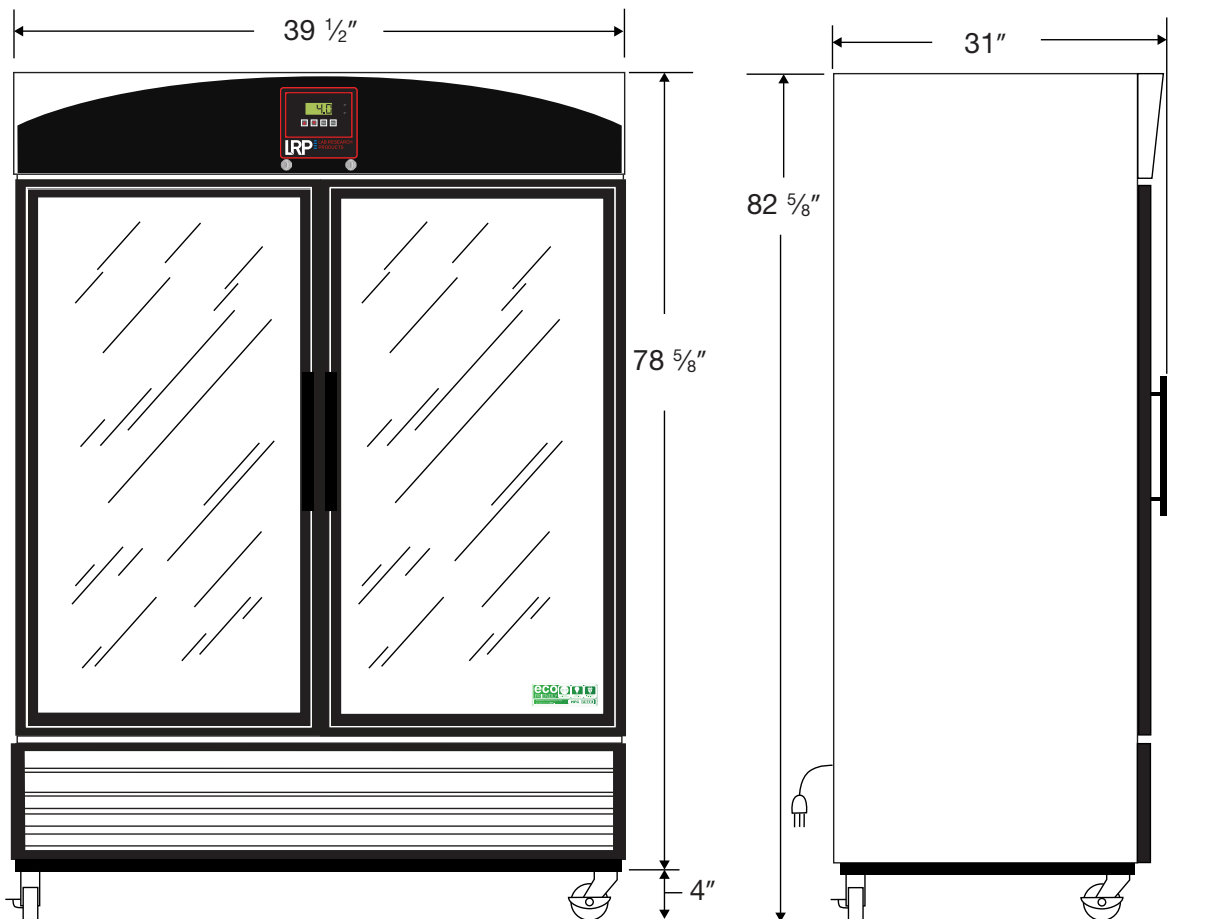

115VAC/60Hz/1PH  
NEMA-5-15P

Cu. Ft	Defrost	Door	Int Door	Shelves	W"	D"	H"	Refrigerant	H.P.	Amps	Weight
35	Cycle	2 Glass	0	8 Adj	39 1/2	31	82 5/8	R290	1/3	6.2	357 lbs.