

CUTSHEET

Front View

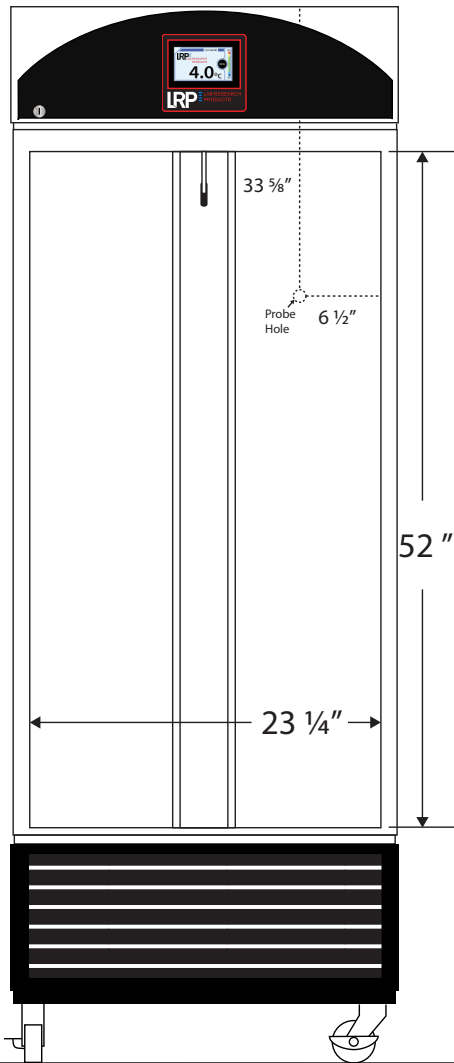

Side View

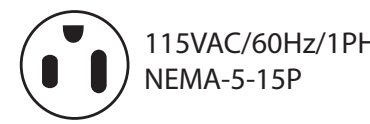
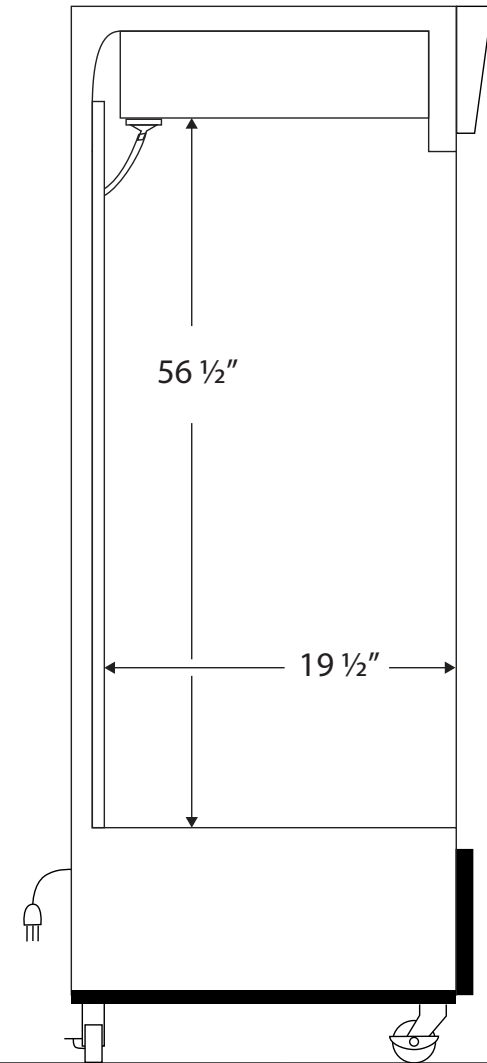

Cu. Ft	Defrost	Door	Int Door	Shelves	W"	D"	H"	Refrigerant	H.P.	Amps	Weight
19	Cycle	1 Glass	0	4 Adj	23 1/4	19 1/2	56 1/2	R290	1/3	5.4	255 lbs.

Note: Interior dimensions are estimates and subject to change without notice