

Front View

Side View

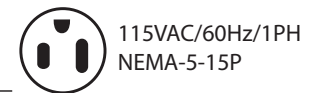
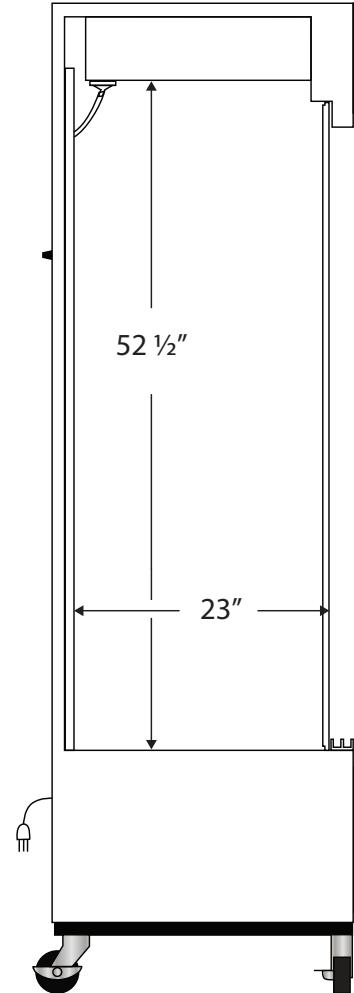
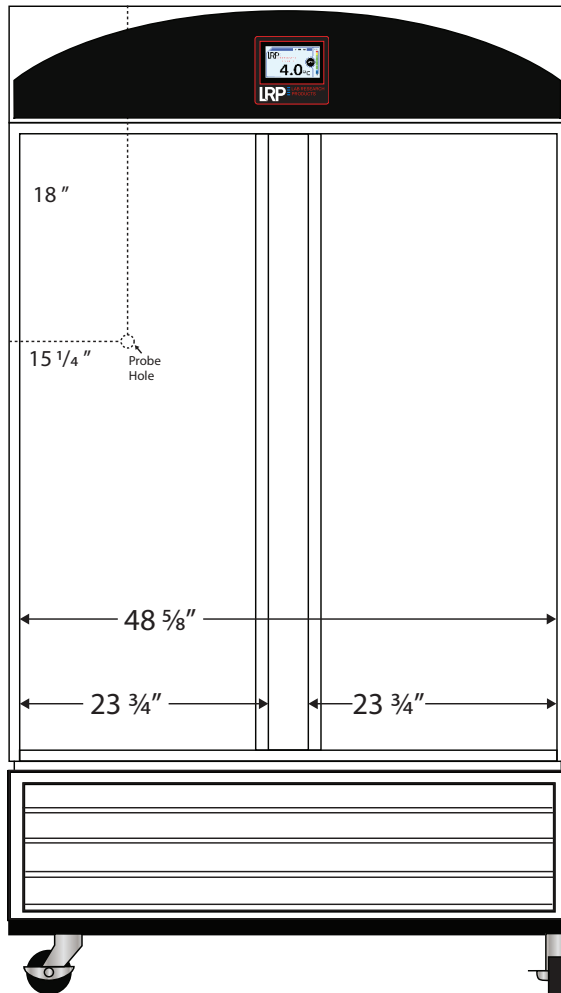

Cu. Ft	Defrost	Door	Int Door	Shelves	Interior Dim.			Refrigerant	H.P.	Amps	Weight
					W"	D"	H"				
47	Cycle	2 Glass (Sliding)	0	8 Adj	48 5/8	23	52 1/2	R290	1/4	4.5	458 lbs.

Note: Interior dimensions are estimates and subject to change without notice