

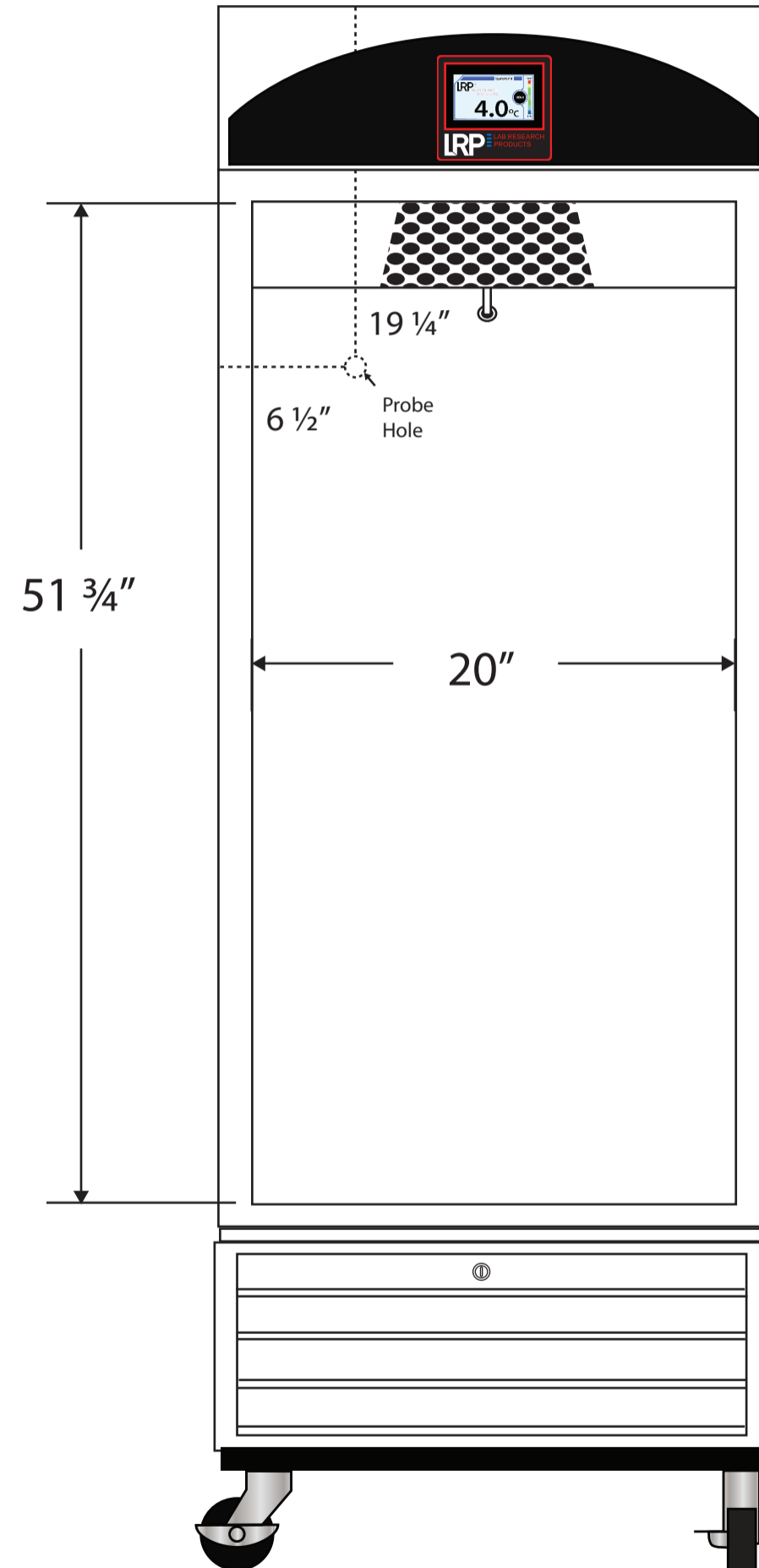

CUTSHEET

Front View

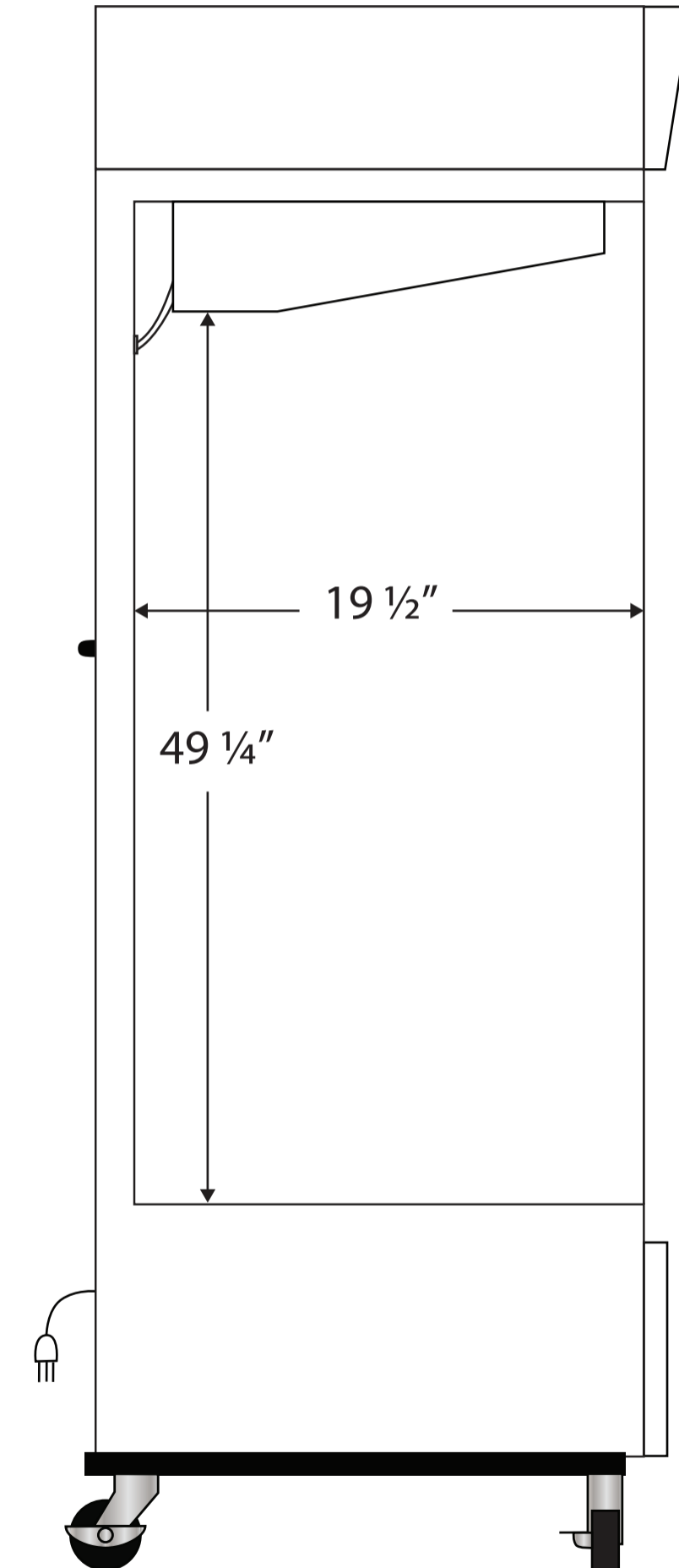

Side View

115VAC/60Hz/1PH
NEMA-5-15P

Cu. Ft	Defrost	Door	Int Door	Shelves	Interior Dim.			Refrigerant	H.P.	Amps	Weight
					W"	D"	H"				
16	Cycle	1 Solid	0	3 Adj	20	19 1/2	49 1/4	R290	1/5	3	237 lbs.

Note: Interior dimensions are estimates and subject to change without notice