

Front View

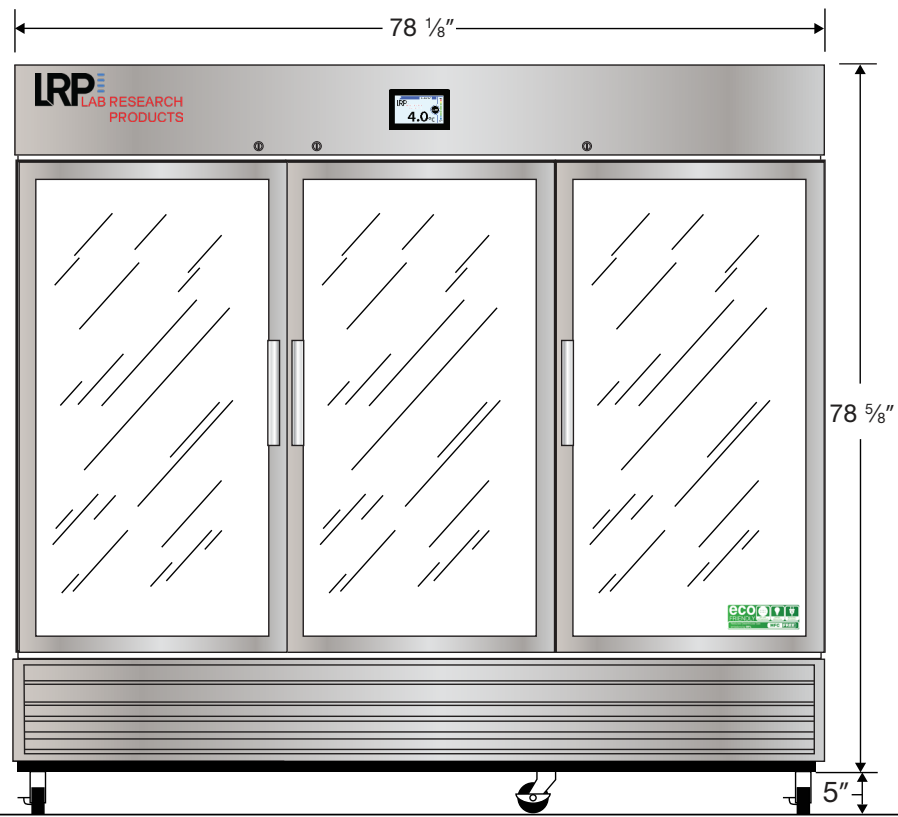

Side View

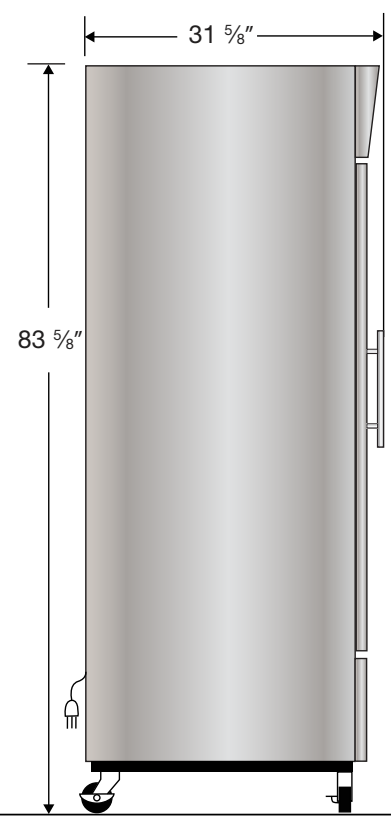

Top View

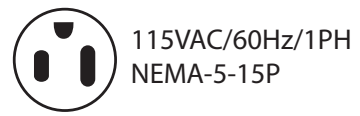
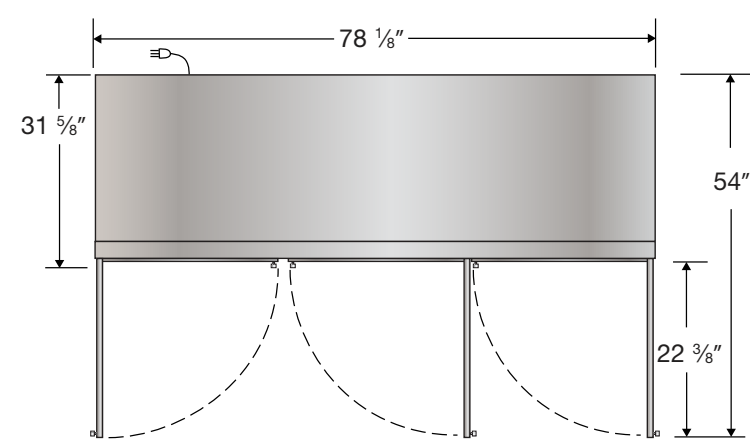

Cu. Ft	Defrost	Door	Int Door	Shelves	W"	D"	H"	Refrigerant	H.P.	Amps	Weight
72	Cycle	3 Glass	0	9 Adj	78 1/8	31 5/8	83 5/8	R290	3/4	6.9	645 lbs.