

Front View

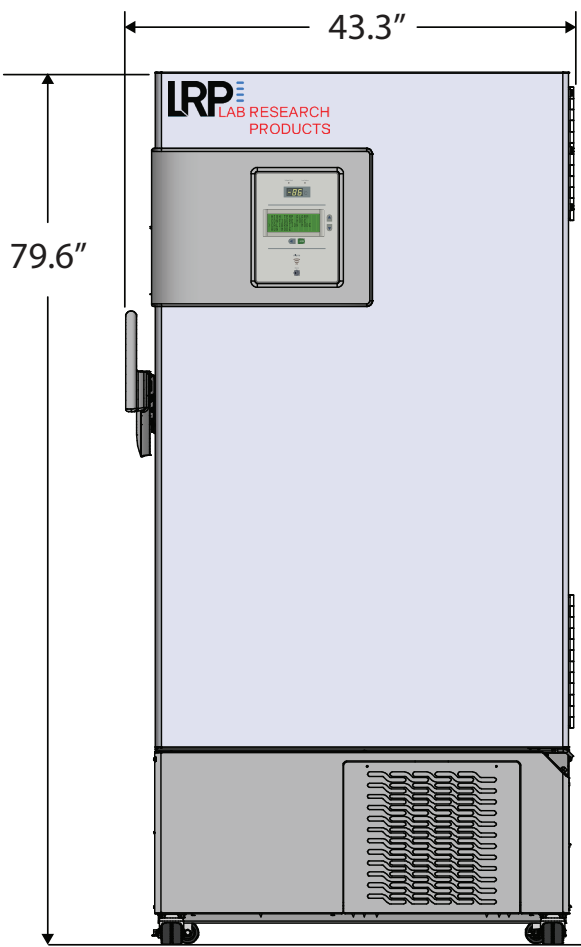

Side View

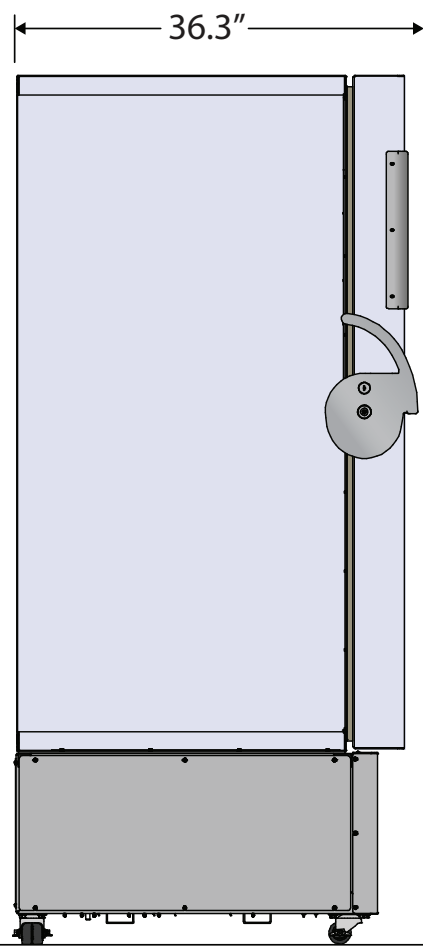

Top View

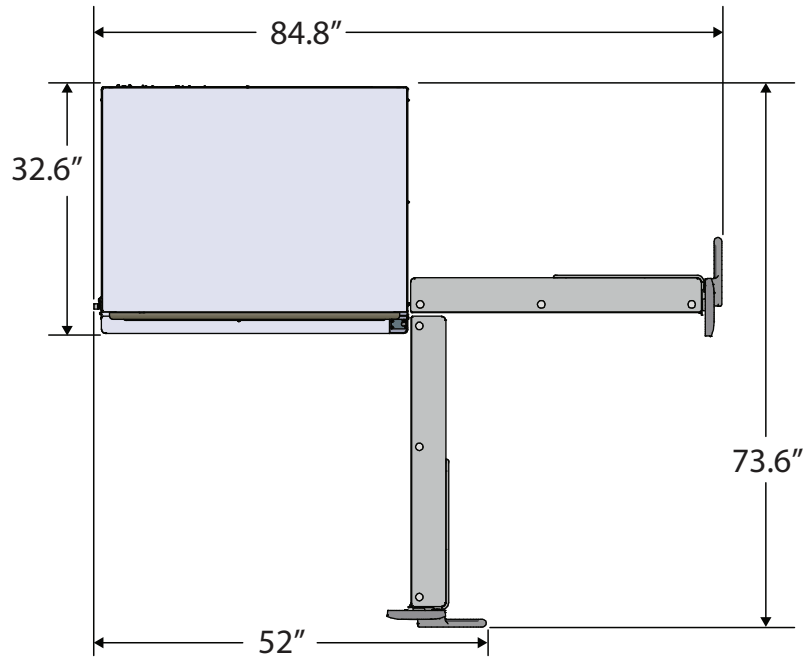

230VAC/60Hz/1PH
 NEMA-6-15P

| Cu. Ft | Defrost | Door | Int Door | Shelves | W" | D" | H" | H.P. | Amps | Weight |
|--------|---------|---------|----------|---------|------|------|------|-------|------|----------|
| 21 | Manual | 1 Solid | 5 | 4 Fixed | 43.3 | 36.3 | 79.6 | ½ x ½ | 10 | 680 lbs. |