

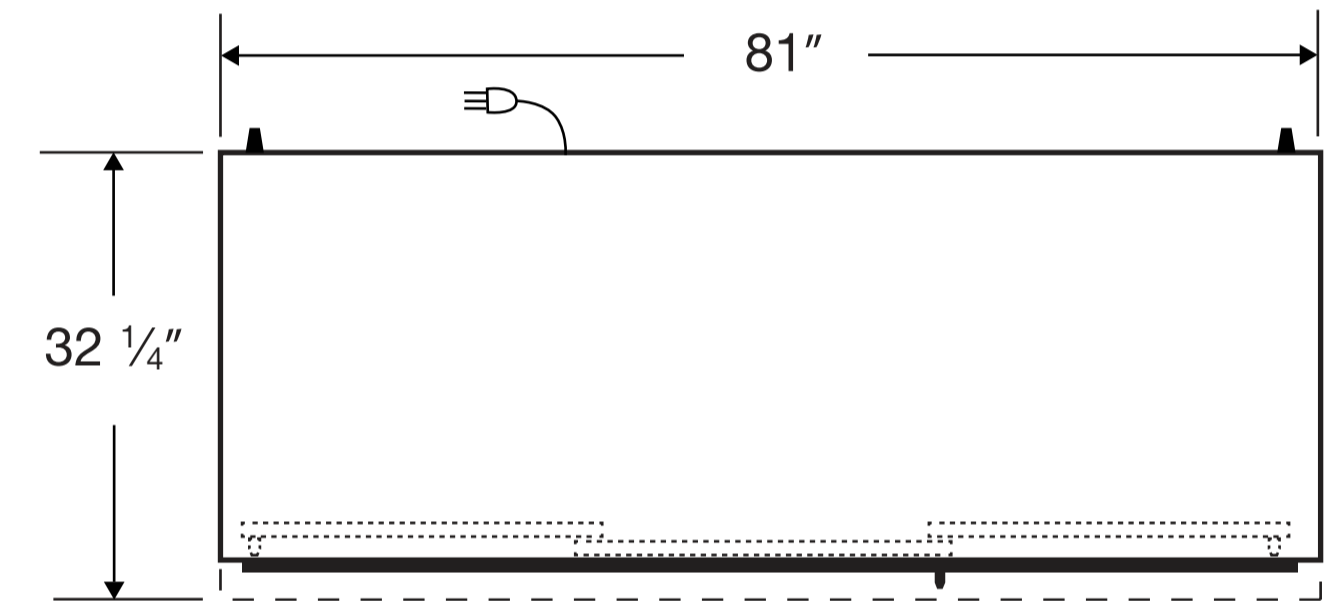

Front View

Side View

Top View

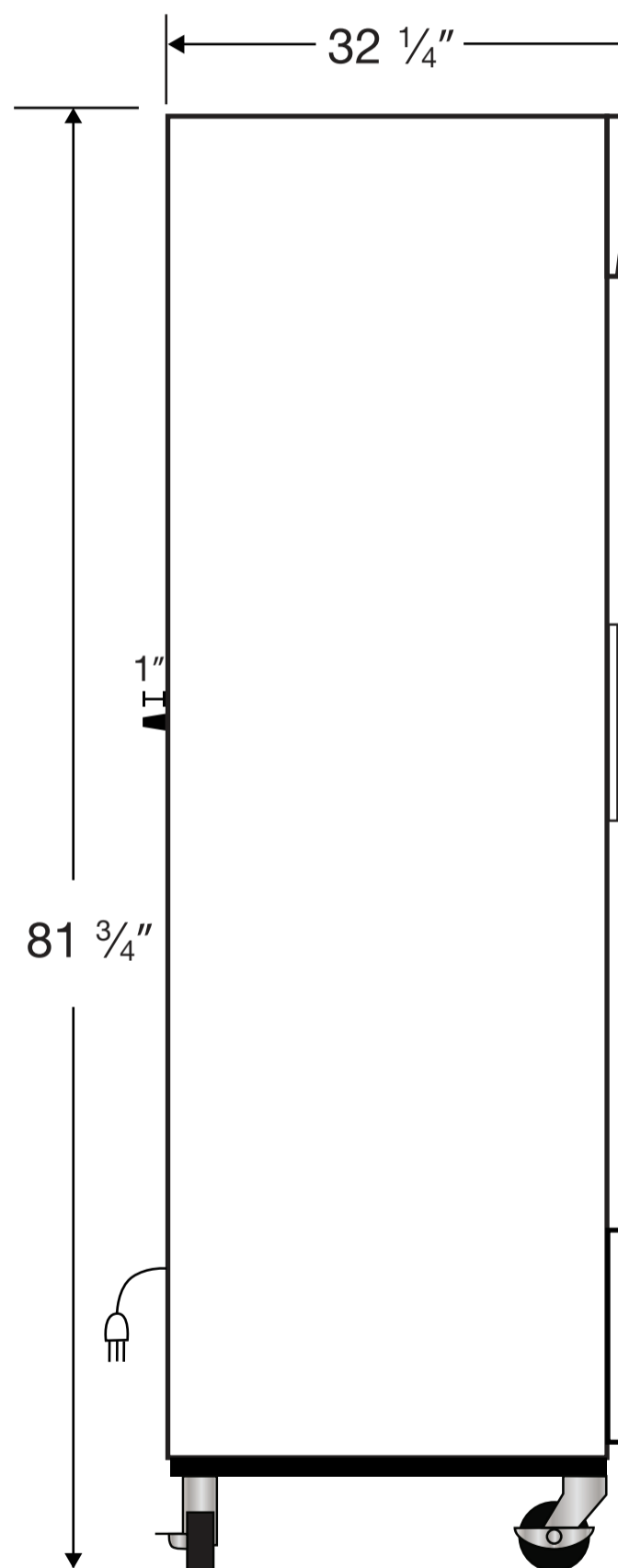
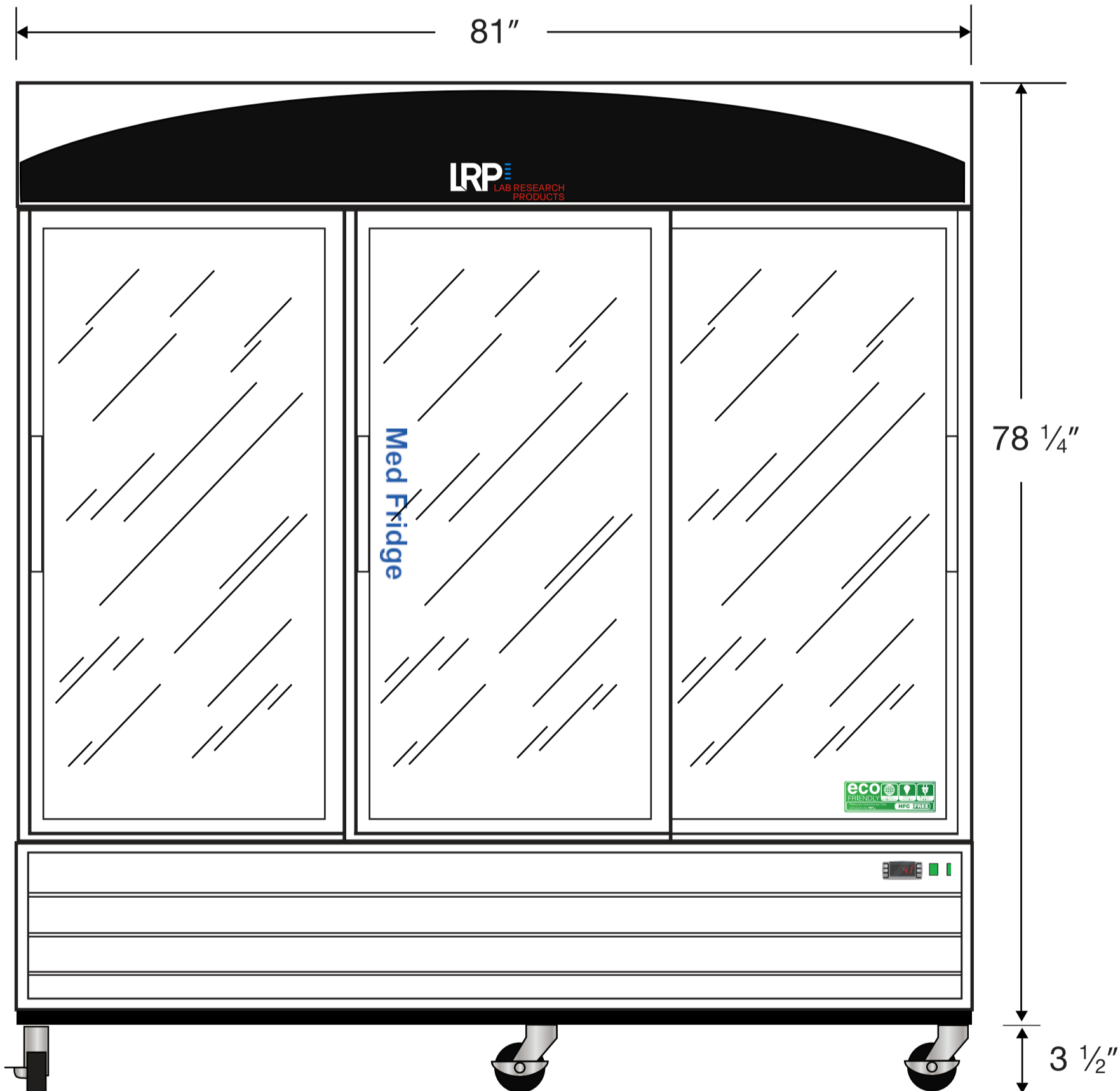

 115VAC/60Hz/1PH
NEMA-5-15P

Cu. Ft	Defrost	Door	Int Door	Shelves	W"	D"	H"	Refrigerant	H.P.	Amps	Weight
69	Cycle	3 Glass (Sliding)	0	12 Adj.	81	33 1/4	81 3/4	R290	1/2	7.5	688 lbs.