

Front View

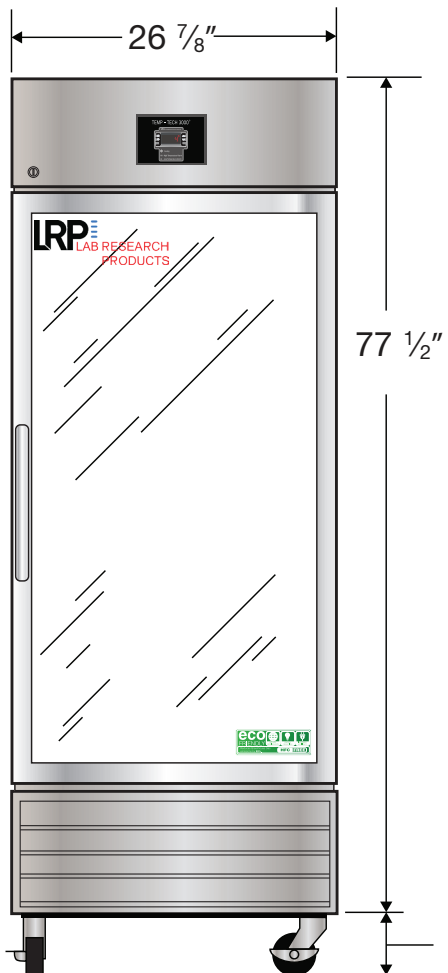

Side View

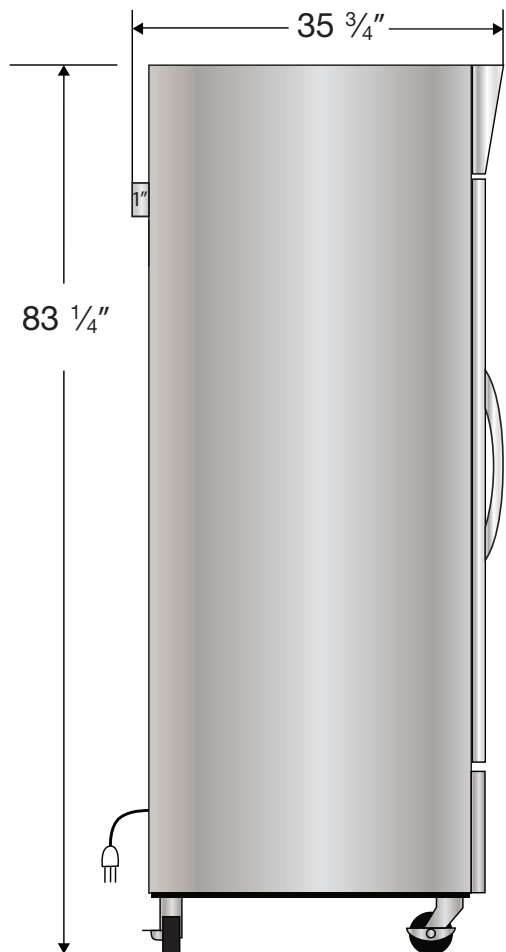

Top View

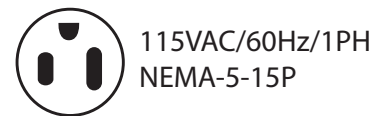
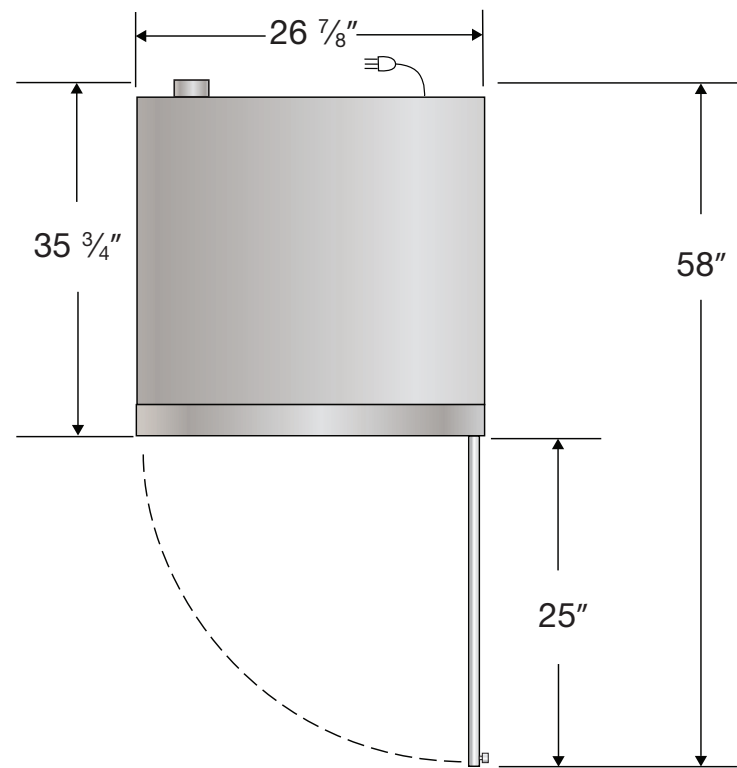

Cu. Ft	Defrost	Door	Int Door	Shelves	W"	D"	H"	Refrigerant	H.P.	Amps	Weight
23	Cycle	1 Glass	0	4 Adj	26 7/8	35 3/4	83 1/4	R290	1/5	3	325 lbs.