

CUTSHEET

Front View

Side View

Top View

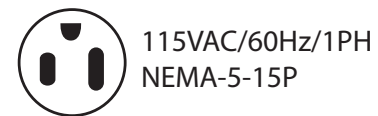
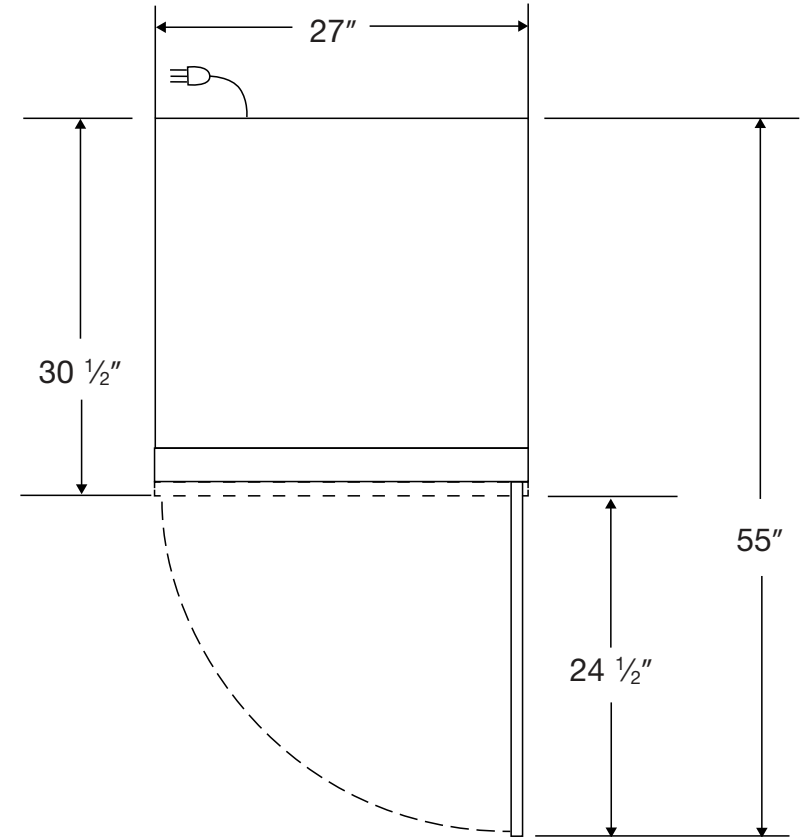
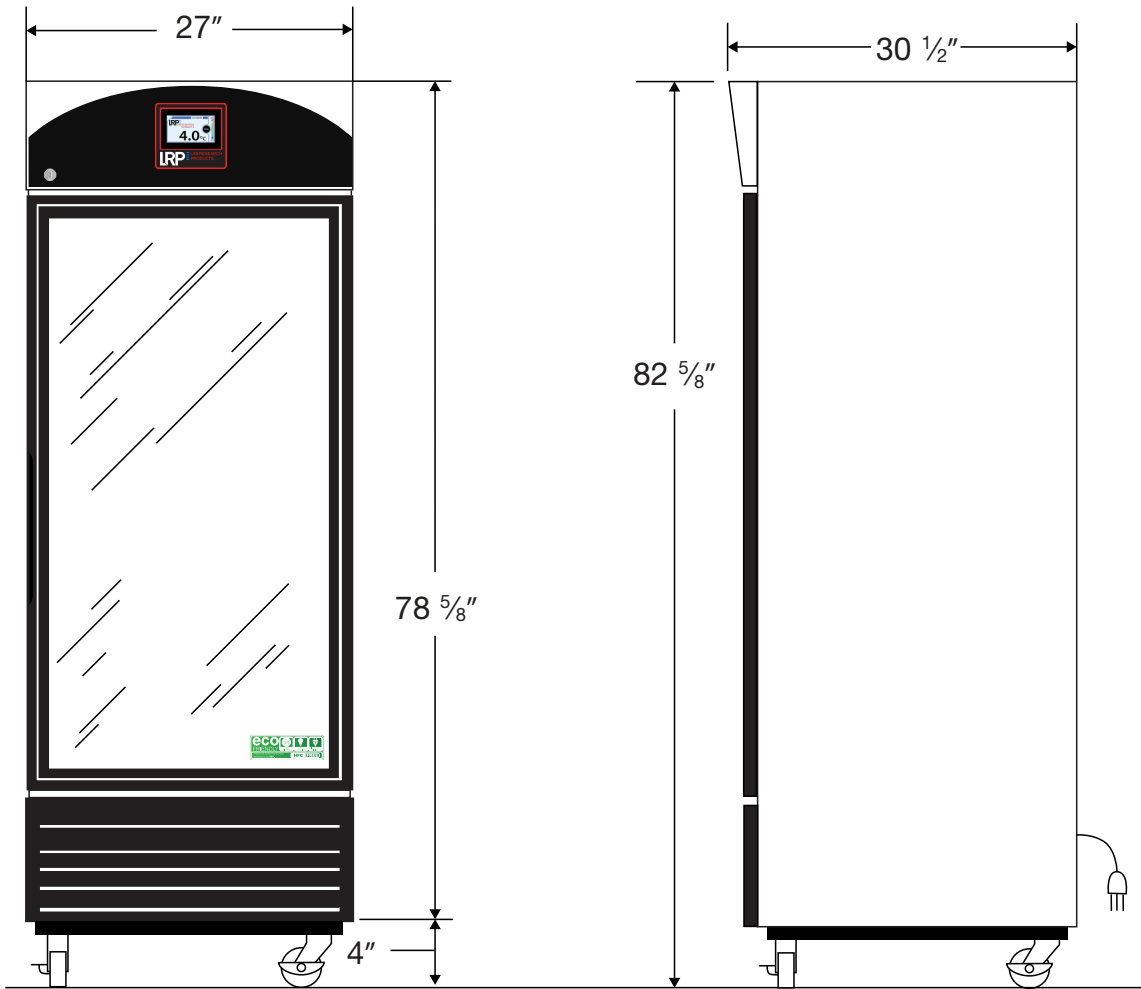

115VAC/60Hz/1PH
NEMA-5-15P

Cu. Ft	Defrost	Door	Int Door	Shelves	W"	D"	H"	Refrigerant	H.P.	Amps	Weight
23	Cycle	1 Glass	0	4 Adj	27	30 1/2	82 5/8	R290	1/3	5.4	335 lbs.