

CUTSHEET

Front View

Side View

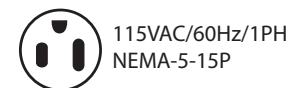
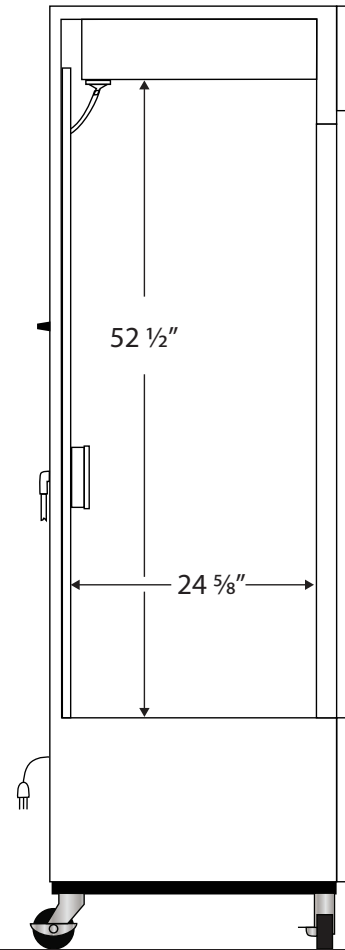
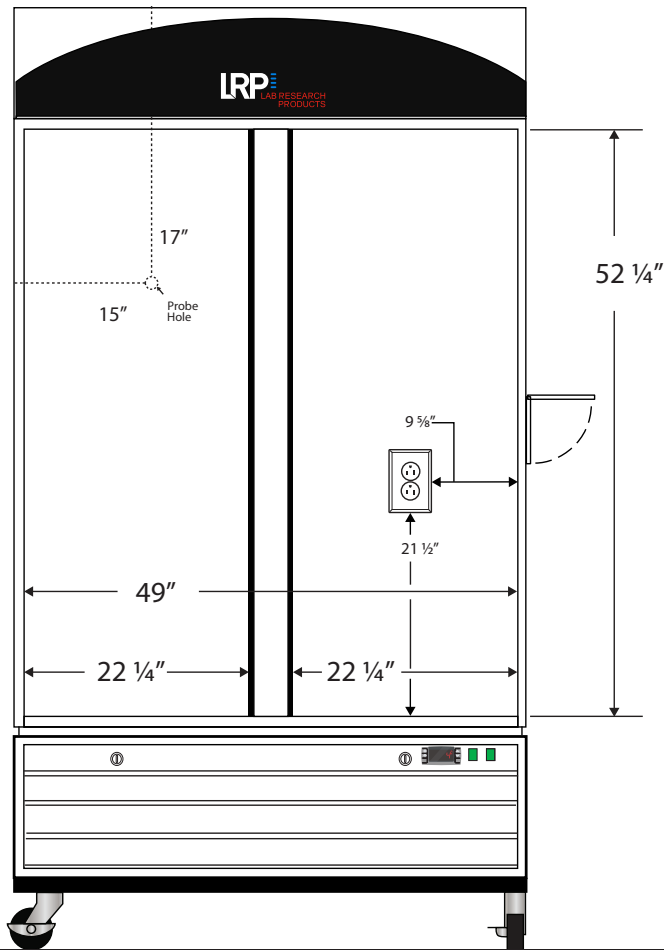

Cu. Ft	Defrost	Door	Int Door	Shelves	W"	D"	H"	Refrigerant	H.P.	Amps	Weight
49	Cycle	2 Glass	0	8 Adj	49	24 5/8	52 1/2	R290	1/4	4.5	488 lbs.

Note: Interior dimensions are estimates and subject to change without notice