

CUTSHEET

Front View

Side View

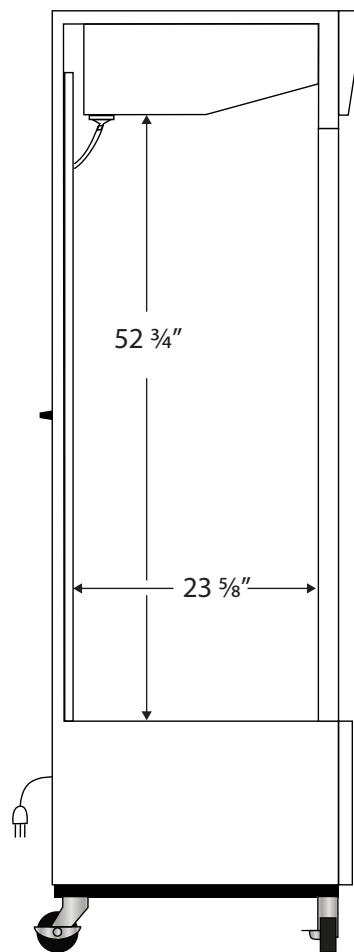
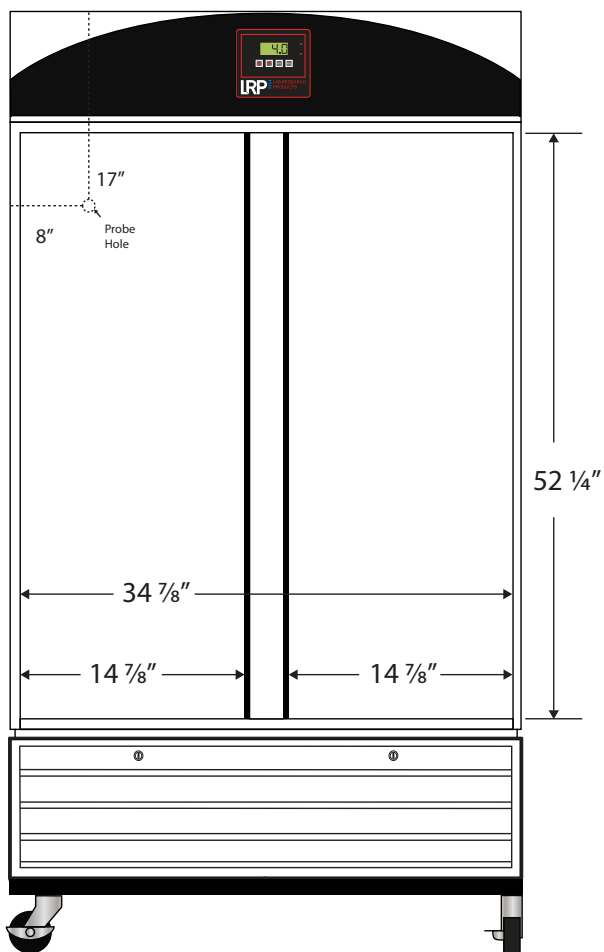

Cu. Ft	Defrost	Door	Int Door	Shelves	W"	D"	H"	Refrigerant	H.P.	Amps	Weight
36	Cycle	2 Glass	0	8 Adj	34 7/8	23 5/8	52 3/4	R290	1/4	4.5	355 lbs.

Note: Interior dimensions are estimates and subject to change without notice