

Front View

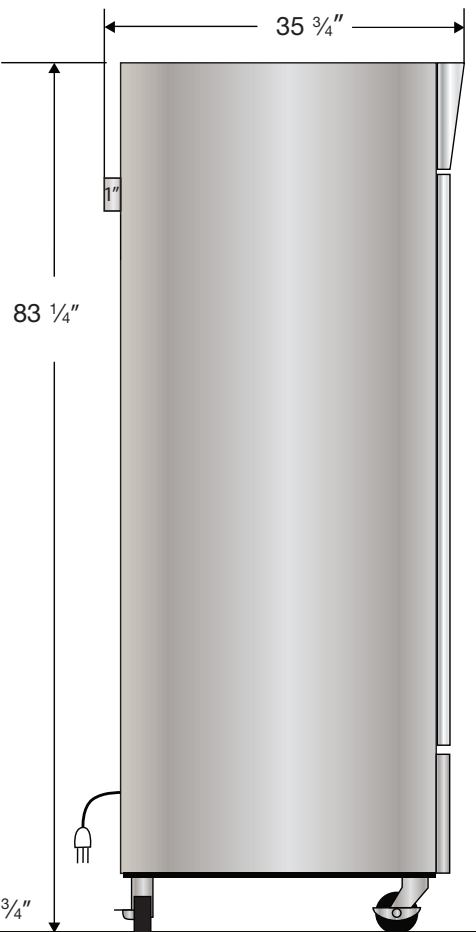

Side View



Top View

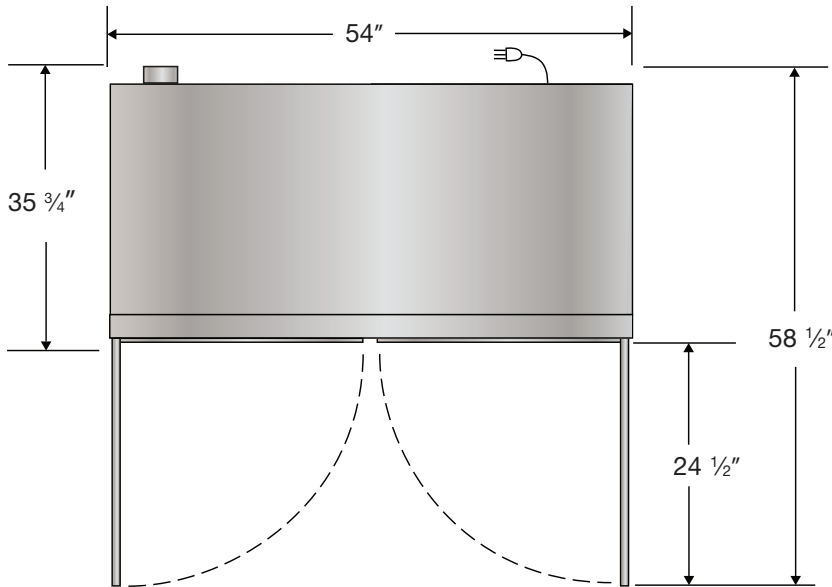

115VAC/60Hz/1PH
NEMA-5-15P

Cu. Ft	Defrost	Door	Int Door	Shelves	W"	D"	H"	Refrigerant	H.P.	Amps	Weight
49	Auto	2 Solid	0	6 Adj.	54	35 3/4	83 1/4	R290	3/4	9	450 lbs.