

Front View

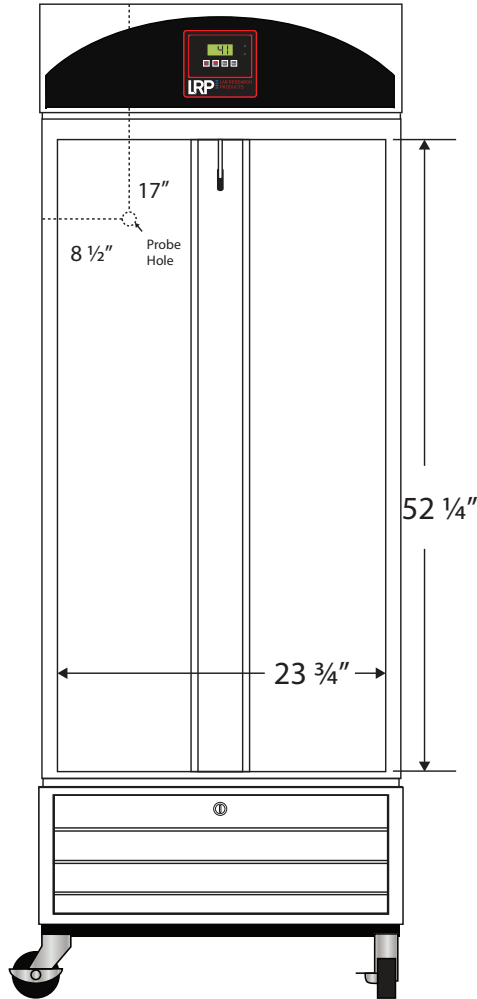

Side View

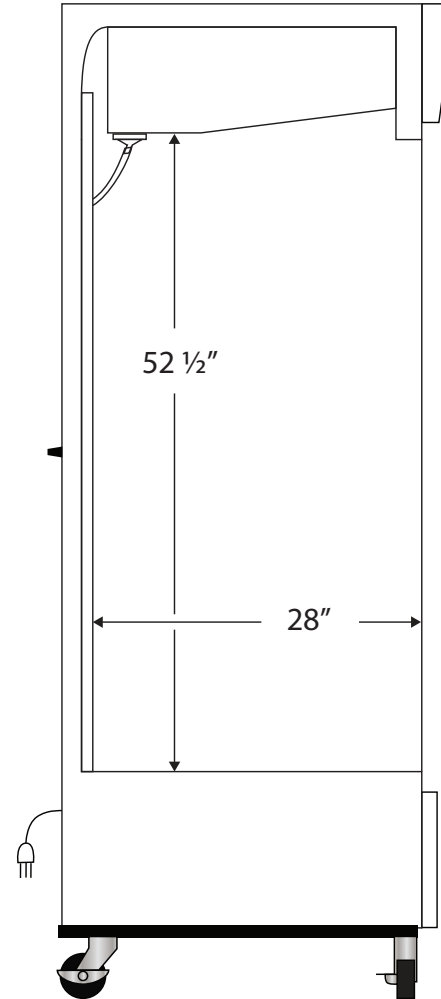

115VAC/60Hz/1PH
NEMA-5-15P

Cu. Ft	Defrost	Door	Int Door	Shelves	Interior Dim.			Refrigerant	H.P.	Amps	Weight
					W"	D"	H"				
26	Cycle	1 Solid	0	6 Adj	23 3/4	28	52 1/2	R290	1/5	3	235 lbs.

Note: Interior dimensions are estimates and subject to change without notice