

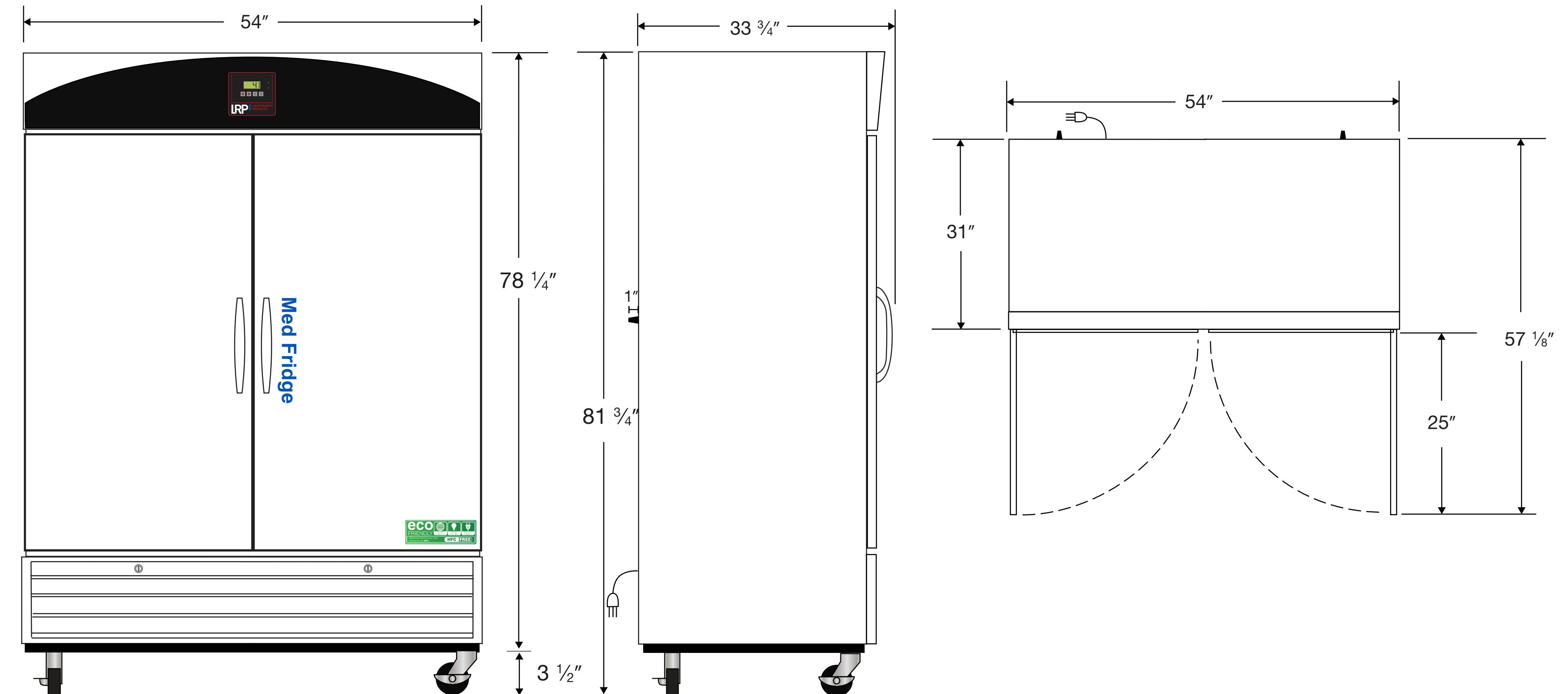

Front View

Side View

Top View



 115VAC/60Hz/1PH
NEMA-5-15P

Cu. Ft	Defrost	Door	Int Door	Shelves	W"	D"	H"	Refrigerant	H.P.	Amps	Weight
49	Cycle	2 Solid	0	12 Adj.	54	34 3/4	81 3/4	R290	1/4	4.5	396 lbs.