

Front View

Side View

Top View

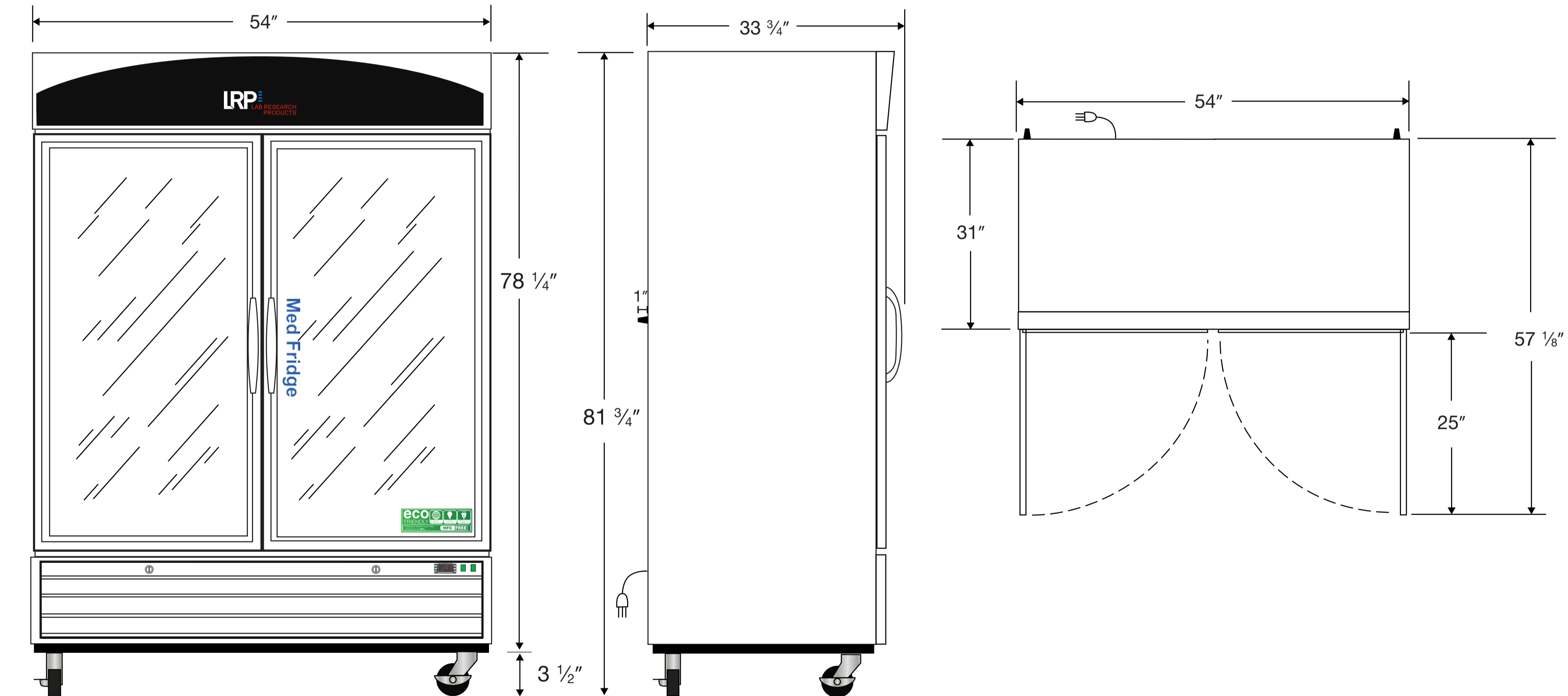

115VAC/60Hz/1PH
NEMA-5-15P

| Cu. Ft | Defrost | Door | Int Door | Shelves | W" | D" | H" | Refrigerant | H.P. | Amps | Weight |
|--------|---------|---------|----------|---------|----|--------|--------|-------------|------|------|----------|
| 49 | Cycle | 2 Glass | 0 | 8 Adj. | 54 | 34 3/4 | 81 3/4 | R290 | 1/4 | 4.5 | 488 lbs. |