

Front View

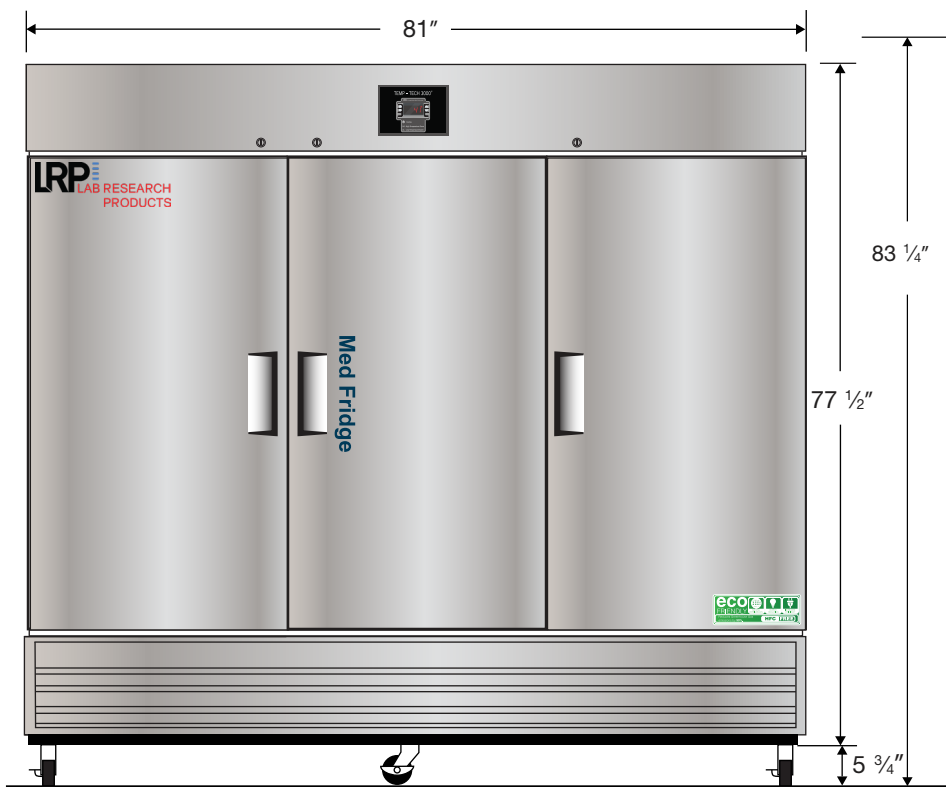

Side View



Top View

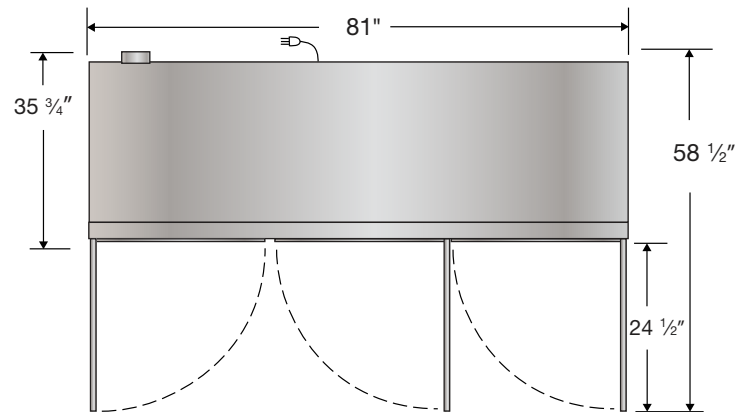

115VAC/60Hz/1PH
NEMA-5-15P

Cu. Ft	Defrost	Door	Int Door	Shelves	W"	D"	H"	Refrigerant	H.P.	Amps	Weight
72	Cycle	3 Solid	0	9 Adj.	81	35 3/4	83 1/4	R290	1/2	7.5	605 lbs.