

Front View

Side View

Top View

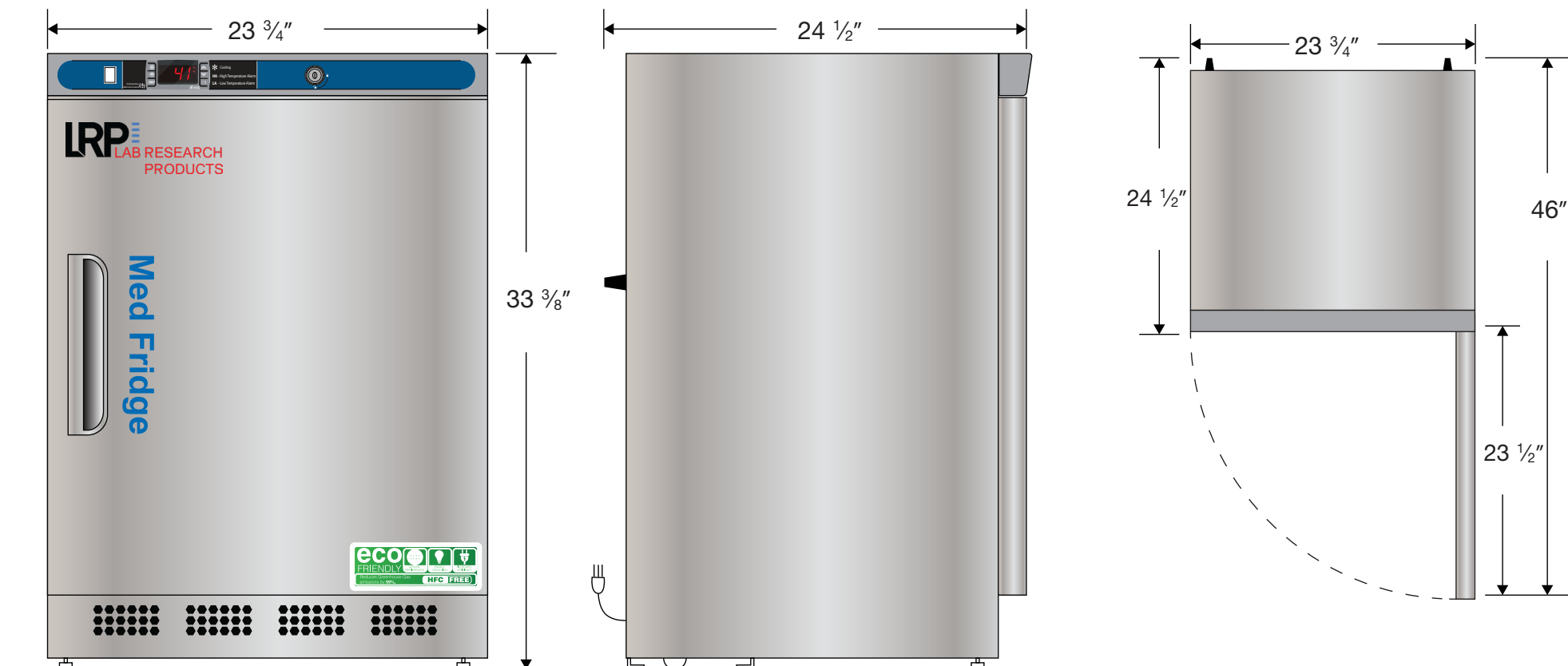

115VAC/60Hz/1PH
NEMA-5-15P

Cu. Ft	Defrost	Door	Int Door	Shelves	W"	D"	H"	Refrigerant	H.P.	Amps	Weight
4.5	Cycle	1 Solid	0	2Adj/1 Fixed	23 3/4	24 1/2	33 3/8	R600a	1/8	1.74	100 lbs.